

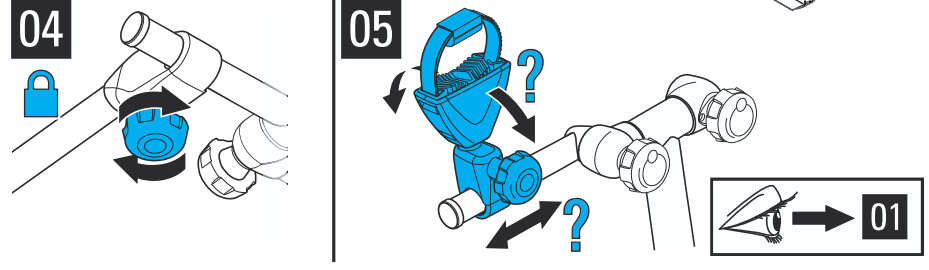

Using the ratchet straps

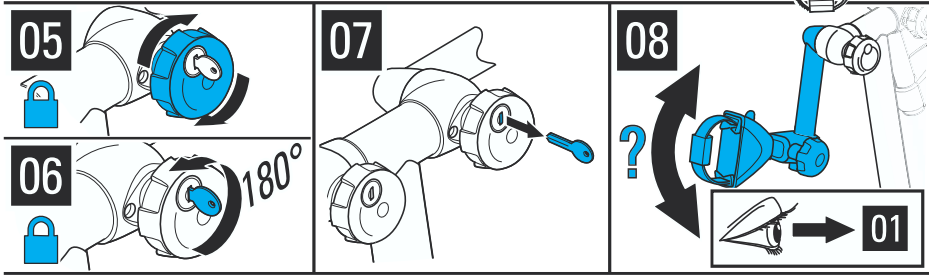

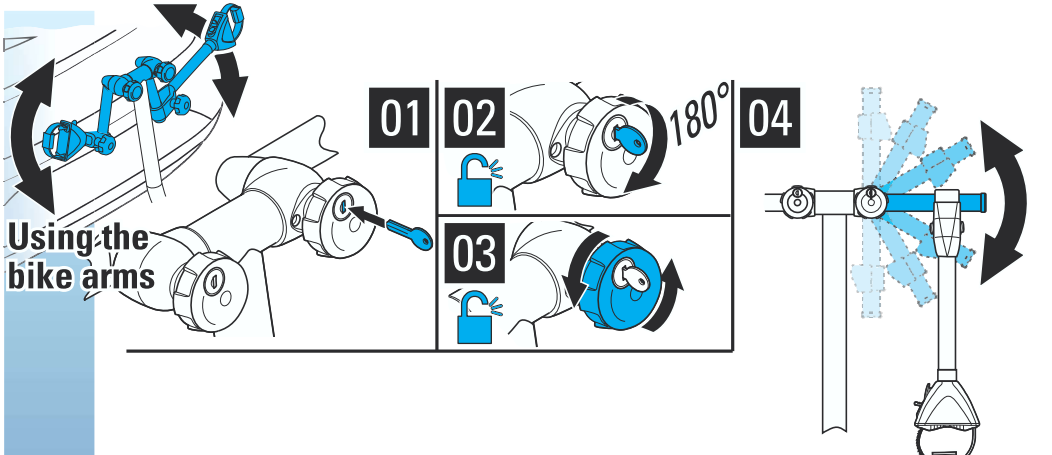

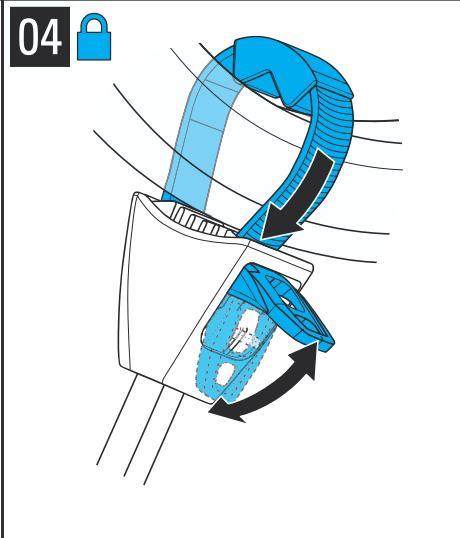
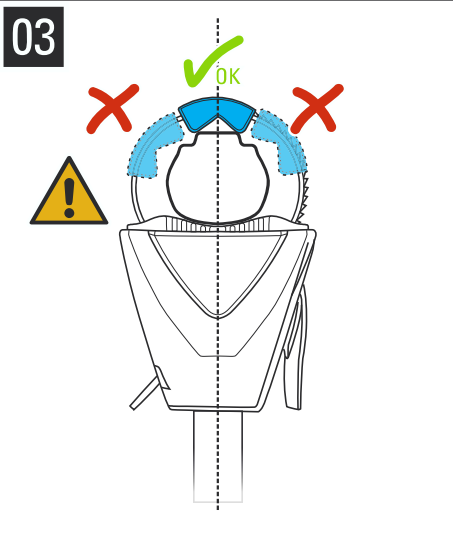
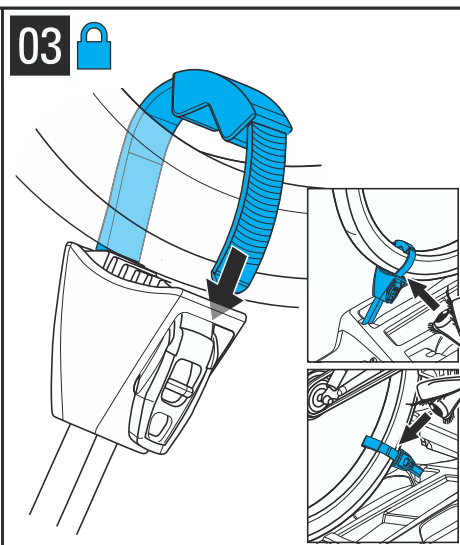
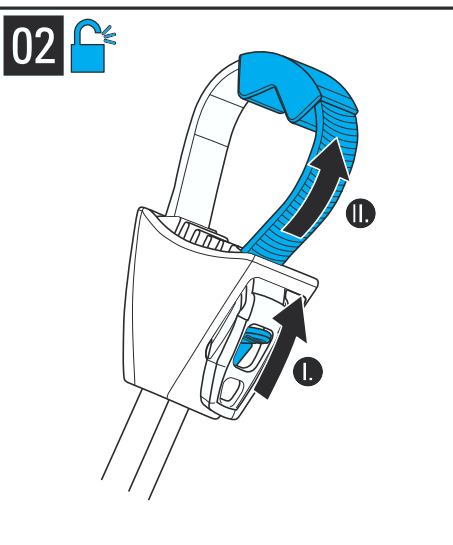
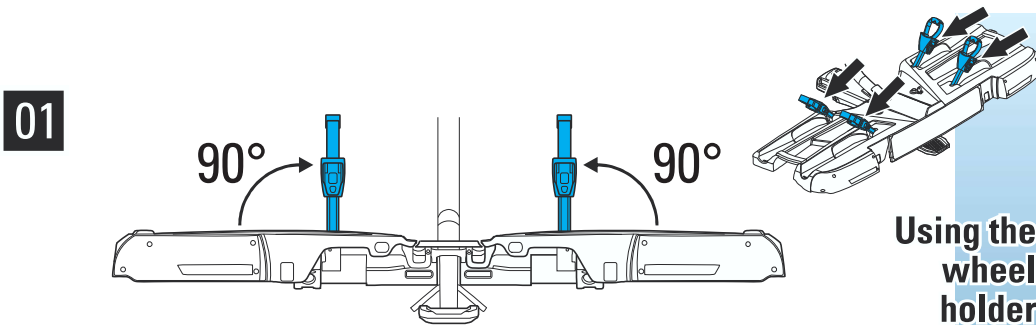
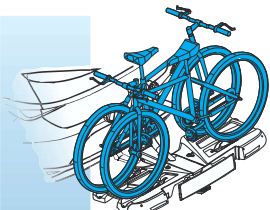





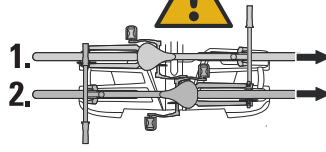



## Mounting the bikes



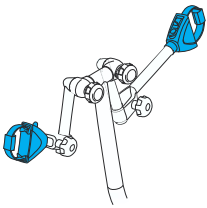

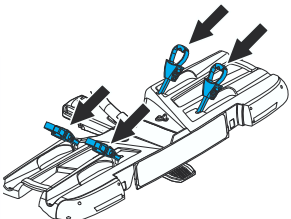
1. 

2. 

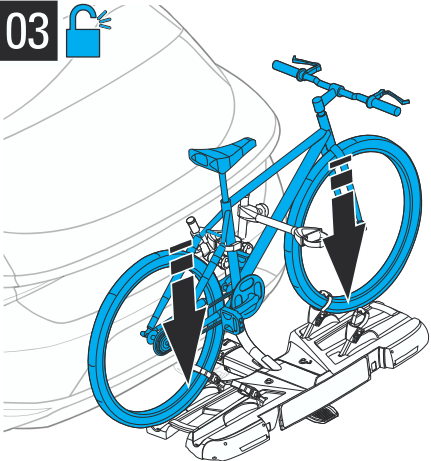
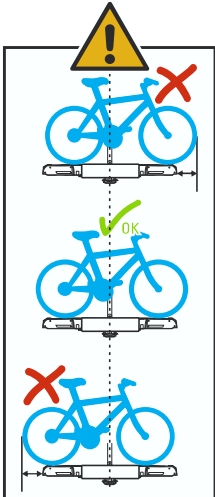
<b>MAX 60kg</b>
MAX 30 kg + MAX 30 kg
<b>60 kg</b>
 OK

<p><b>01</b> </p> <p><b>PAGE 13/24</b></p> <p></p> 	<p><b>02</b> </p> <p><b>PAGE 15/24</b></p> <p></p> 
--	---

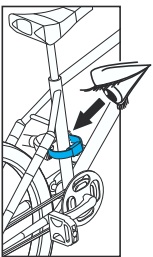
<p><b>03</b> </p> 	
--	---

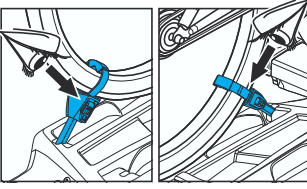
<p><b>04</b> </p> <p><b>PAGE 13/24</b></p> <p></p> 	<p><b>05</b> </p> <p><b>PAGE 15/24</b></p> <p></p> 
--	--

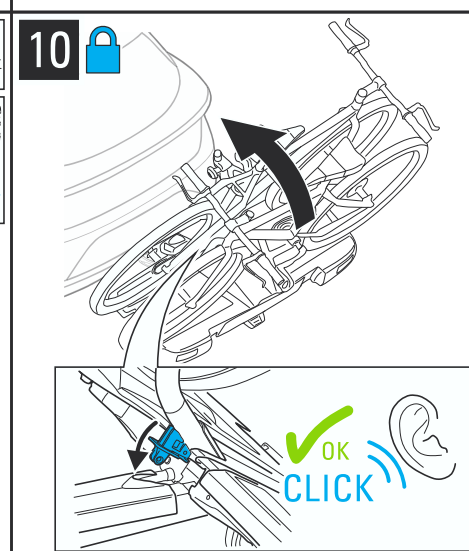
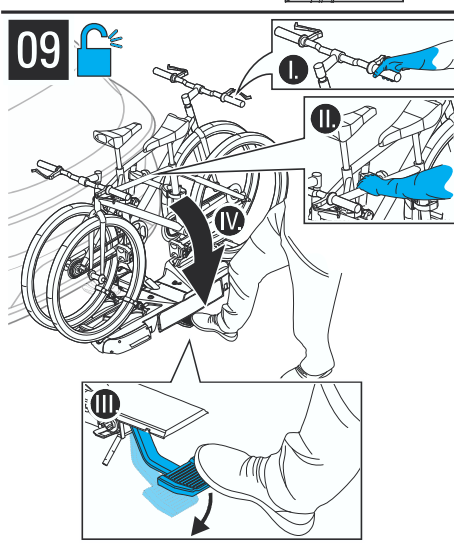
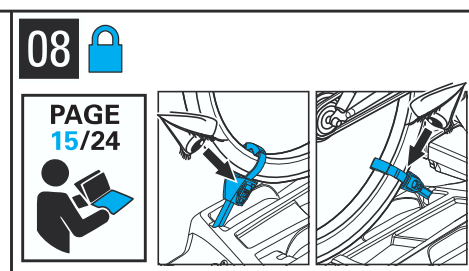
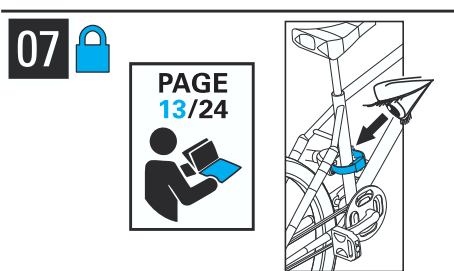
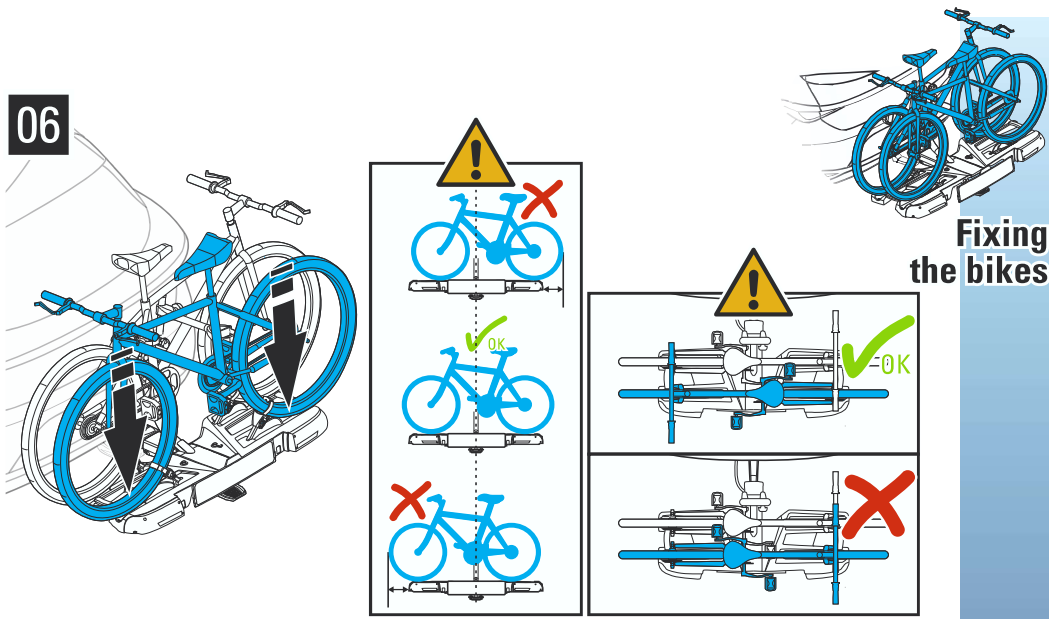

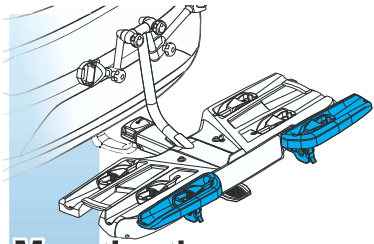

### Mounting the 3rd bike extension

01

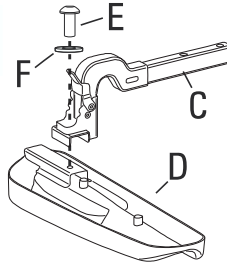

26 Nm



02

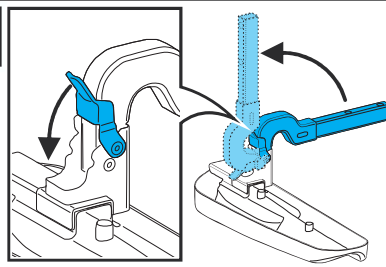

03

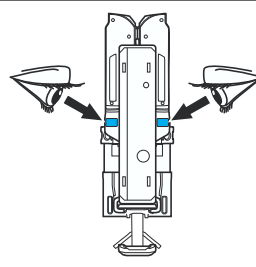

04

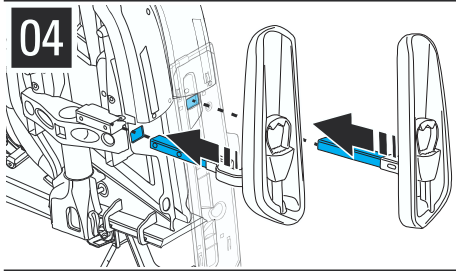

05

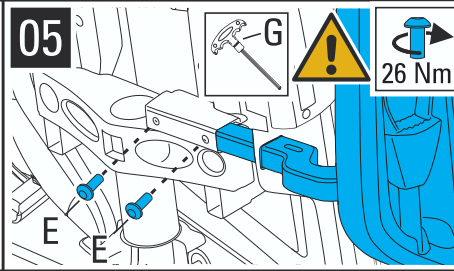

06

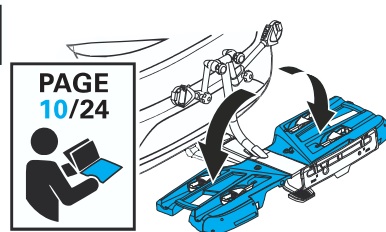

07

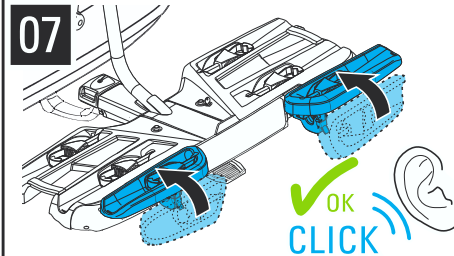

08

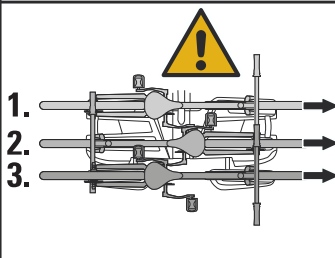
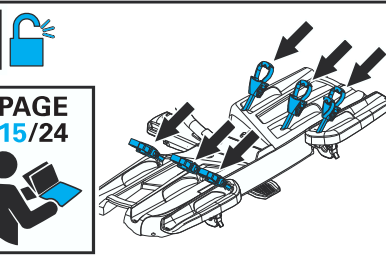

<b>MAX 60kg</b>	
1. 30 kg + 25 kg	23 kg
2. 30 kg + 20 kg	12 kg
3. 80 kg	60 kg

09

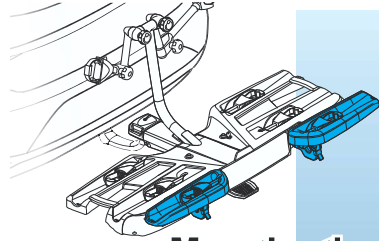
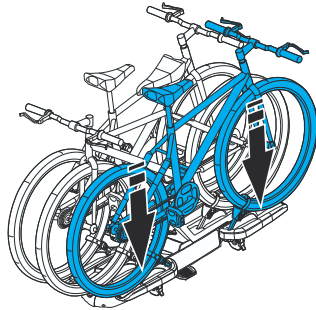

### Mounting the 3rd bike extension

10

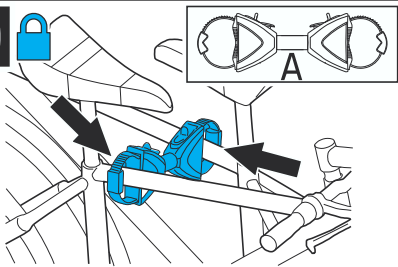

PAGE 13/24

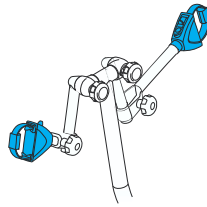

11

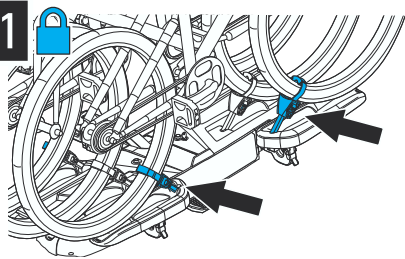

PAGE 15/24

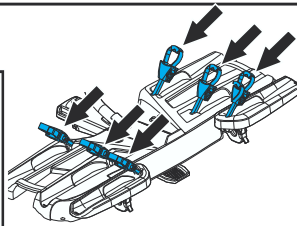

### Attention! Achtung!

While driving the 3rd wheel rail **always** has to be fold up! Otherwise, the taillight is covered!

Während der Fahrt muss die dritte Radschiene **immer** aufgestellt sein! Ansonsten wird das Rücklicht des Fahrradträgers verdeckt!



 **HOCH KLAPPEN!**  
**FOLD UP!**

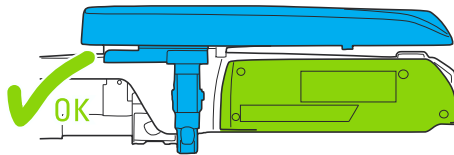
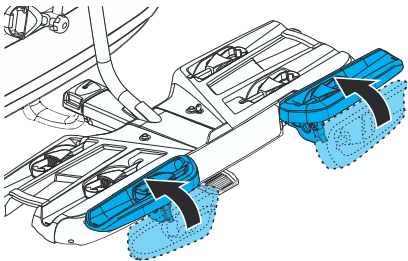
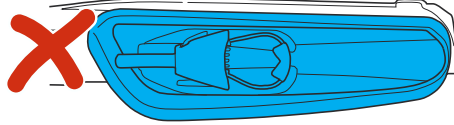

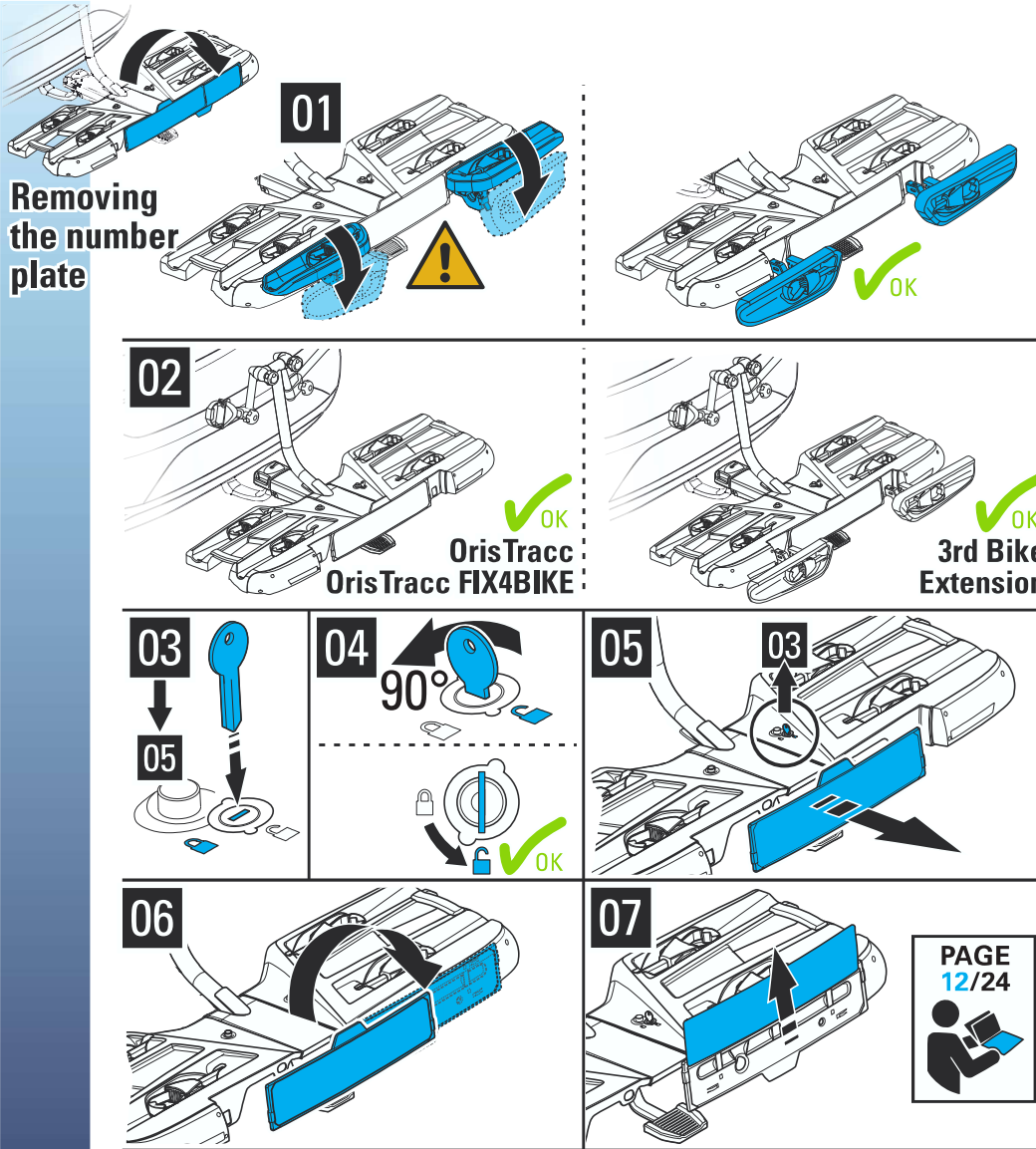

**Removing  
the number  
plate**

**01**



✓ OK

**02**

✓ OK

**OrisTracc  
OrisTracc FIX4BIKE**

✓ OK

**3rd Bike  
Extension**

**03**

**05**

**04**

90°

✓ OK

**05**

**03**

**06**

**07**

**PAGE  
12/24**



01 

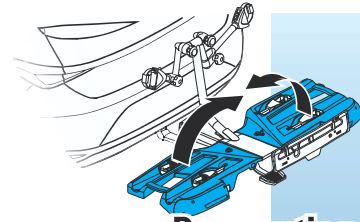
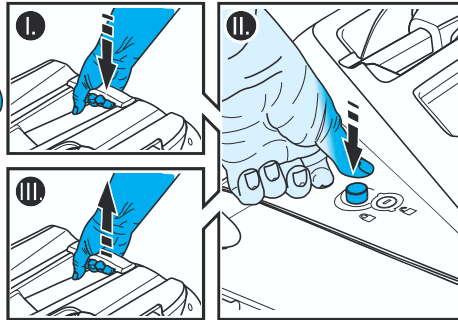
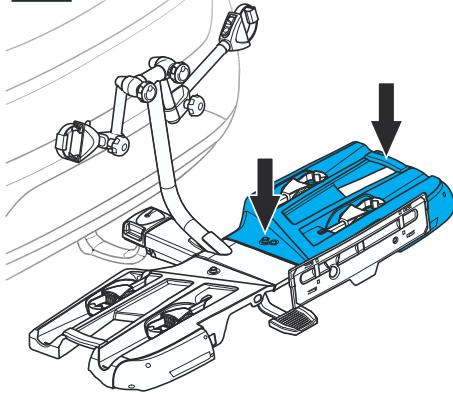

**Demounting  
from the  
Vehicle**

02

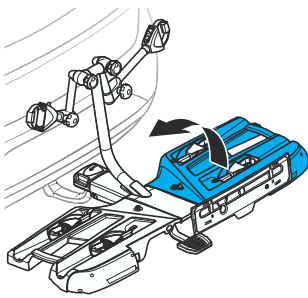

03

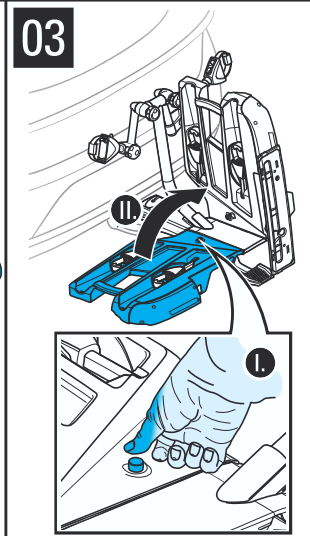

04

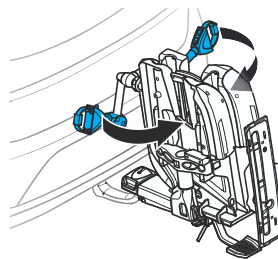

05

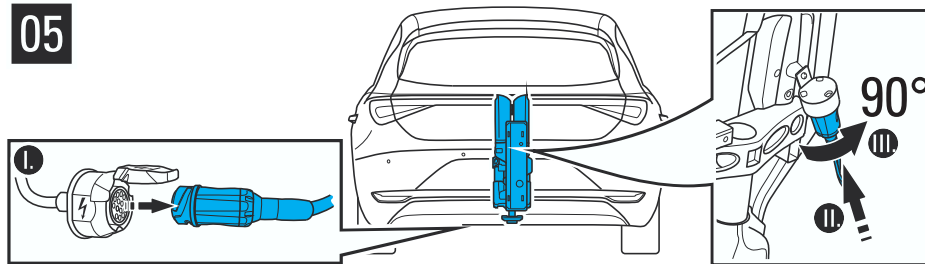

**ORIS**  
ACPS

21/24

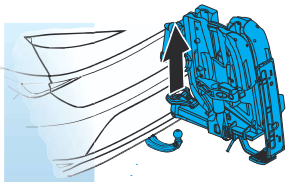

### Demounting the FIX4BIKE System

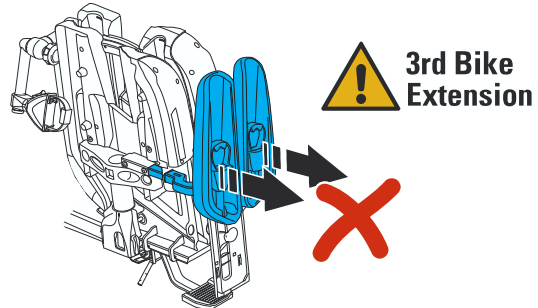

<b>01</b> 	<b>01</b> ✓ OK 3rd Bike Extension 
<b>02</b> 	<b>03</b> 
<b>04</b> 	<b>05</b> 

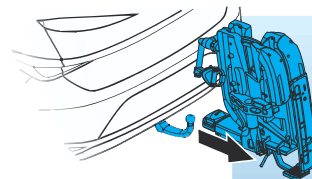
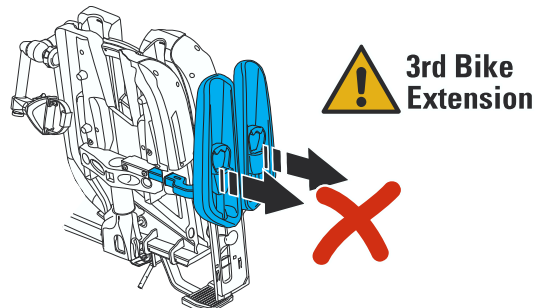

### Demounting the Standard System

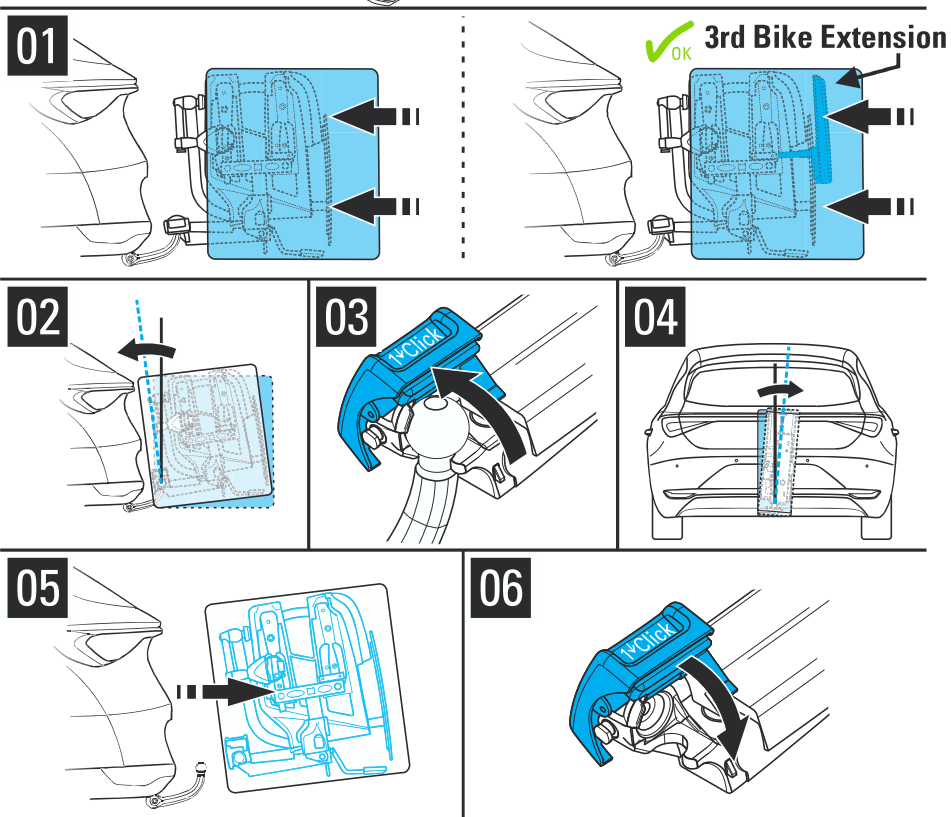

---

**ACPS Automotive Services GmbH**  
Regioparkring 1  
41199 Mönchengladbach, Germany  
Germany

**Phone: +49 2166 943 980 0**  
**Fax: +49 2166 943 980 100**  
**Mai: [BDEV.Sales@acps-automotive.com](mailto:BDEV.Sales@acps-automotive.com)**